

Ensto One Apartment

EVH161-ACRM0

EVH321-ACRM0

EVH161-A2RM0

EVH321-A2RM0

EVH161-A2RMD



Quick Guide



Pikaopas



Snabbguide



Hurtigguide





User Guide

Safety Instructions



WARNING

Danger of electric shock! Risk of fire!

- *People who are not able to operate according to the instructions must not use this charger.*
- *Do not use this charger, if the charger itself or the charging cable appears to be damaged.*
- *Do not use the domestic socket to charge an electric vehicle.*
- *The installation must only be done by an electrically skilled person.*

Ensto One Apartment Features

Available features depend on the charger model.

Ensto collects data from the charging stations connected to the Internet. This anonymized data may be used to develop new digital services and improve user experience and Ensto's offering.

EVH...-ACRMO





EVH...-A2RM0 / EVH161-A2RMD

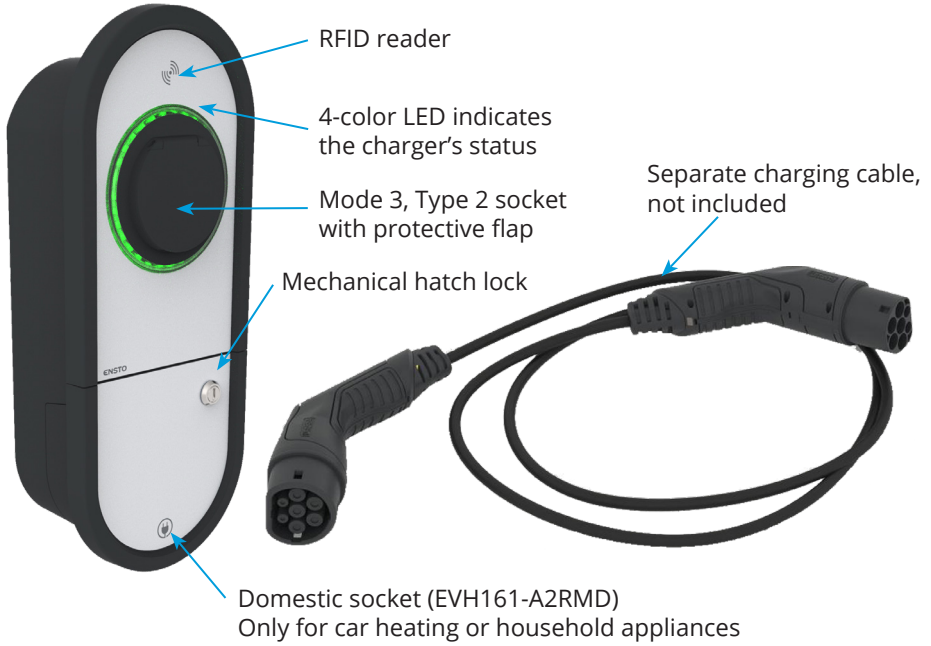

LED Indicator Lights

Charger status	LED
The charger is free and ready to use	
RFID read, authorization ongoing	
Charging authorization rejected	
Authorization accepted, charging allowed	
While you connect the charging cable	
Your vehicle is connected, charging has not started	
Your vehicle is connected, charging starts	
Charging is ongoing	
Error state	
Software update is ongoing. <i>Do not switch off the power or use the charger during the update.</i>	



Charging

EVH161-ACRM0 and EVH132-ACRM0 are equipped with a fixed charging cable.

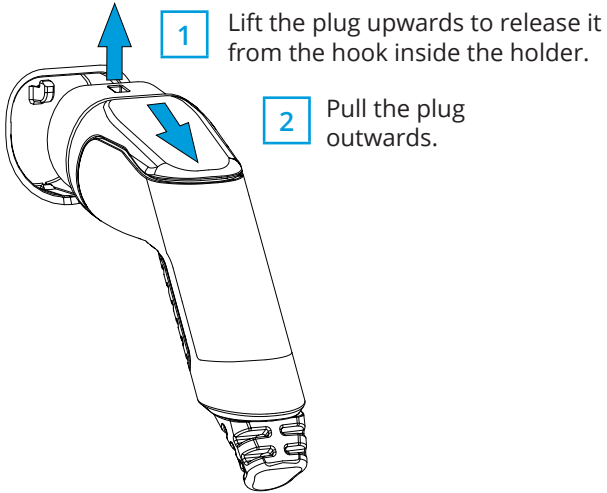

Free charging

1 Plug in to start charging.

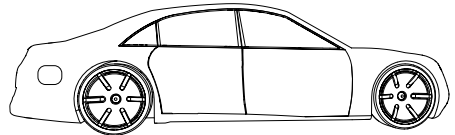
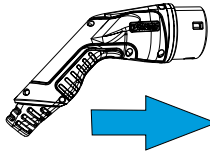
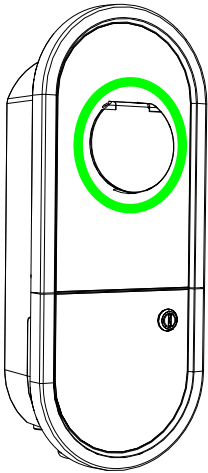

2 Unplug to stop charging.

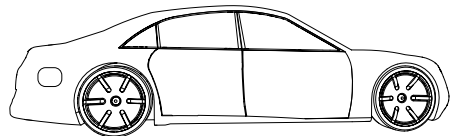
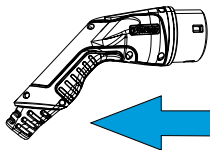



Charging with RFID

- 1** Plug the charging cable to the car.
Plug the charging cable to the charger (EVH...-A2RM0 / EVH161-A2RMD).

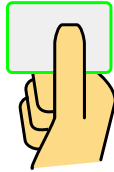
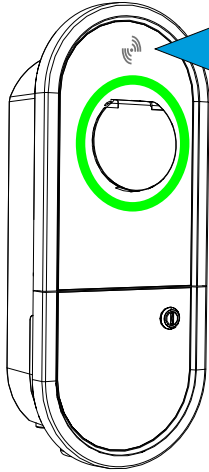
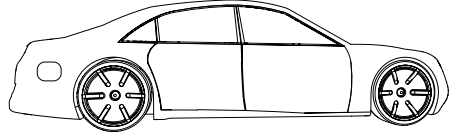
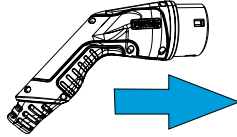

- 2** Show the RFID tag to the RFID reading area.
Charging event starts.

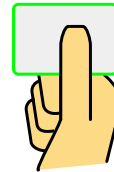
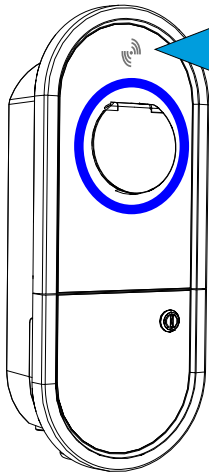

- 3** Show the RFID tag to the RFID reading area.
Charging event ends.

- 4** Unplug the charging cable from the charger (EVH...-A2RM0 / EVH161-A2RMD).
Unplug the charging cable from the car.

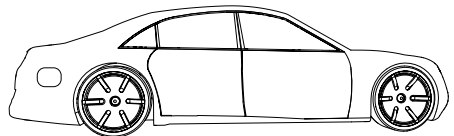
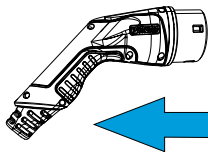

For more detailed instructions please see in the delivery included Installation and User Guide.



Instructions for Installer

Safety Instructions



Electrically skilled person

- The installation must only be done by an electrician with the appropriate qualifications.
- Read in the delivery included Installation and User Guide carefully before you start the installation work.



WARNING

Danger of electric shock! Risk of fire!

- *Improper installation can cause personal injury and property damage.*
- *Do not switch on the power supply before the installation work is completed.*

Power Supply

Protective devices: RCBO is integrated

EVH...-ACRM0 / EVH...-A2RM0

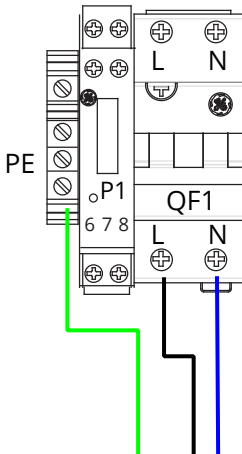

Supply
Cu 2.5 - 10 mm²

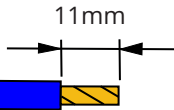

EVH161-A2RMD

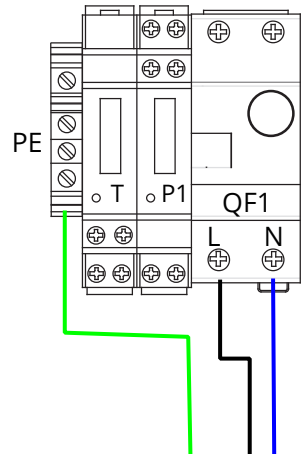

Supply
Cu 2.5 - 10 mm²

Commissioning the charger

You can configure charger's settings with EV Manager. Please see the EV Manager User Manual <https://ewiki.ensto.technology/display/CHWI/EV+Manager>



Käyttöohje

Turvallisuusohjeet



VAROITUS

Sähköiskun vaara! Palovaara!

- *Henkilöt, joilla ei ole riittävää osaamista toimia ohjeen mukaisesti, eivät saa käyttää tätä latauslaitetta.*
- *Älä käytä tätä latauslaitetta, jos latauslaite tai latauskaapeli vaikuttaa vaurioituneelta.*
- *Älä käytä kotitalouspistorasiaa sähköajoneuvon lataamiseen.*
- *Asennuksen saa suorittaa vain sähköalan ammattihenkilö.*

Ensto One Apartment ominaisuudet

Saatavilla olevat ominaisuudet riippuvat latauslaitteen mallista.

Ensto kerää tietoja Internetiin kytketyistä latausasemista. Nämä tiedot ovat nimettömiä ja niitä voidaan käyttää uusien digitaalisten palvelujen kehittämiseen sekä käyttökokemuksen ja Enston tarjonnan parantamiseen.

EVH...-ACRM0





EVH...-A2RM0 / EVH161-A2RMD



LED merkkivalot

Latauslaitteen tila	LED
Latauslaite on vapaa ja käyttövalmis	
RFID-tunniste luettu, käyttäjän tunnistautuminen käynnissä	
Latauslupaa ei myönnetty	
Latauslupa on myönnetty, voit aloittaa lataamisen	
Latauskaapelia kytkettäessä	
Ajoneuvo on kytketty, latausta ei ole aloitettu	
Ajoneuvo on kytketty, lataustapahtuman aloitus	
Lataus on käynnissä	
Vikatilanne	
Ohjelmiston päivitys käynnissä. Älä katkaise virtaa tai käytä latauslaitetta päivityksen aikana.	



Lataaminen

Latauslaitteissa EVH161-ACRM0 ja EVH132-ACRM0 on kiinteä latauskaapeli.

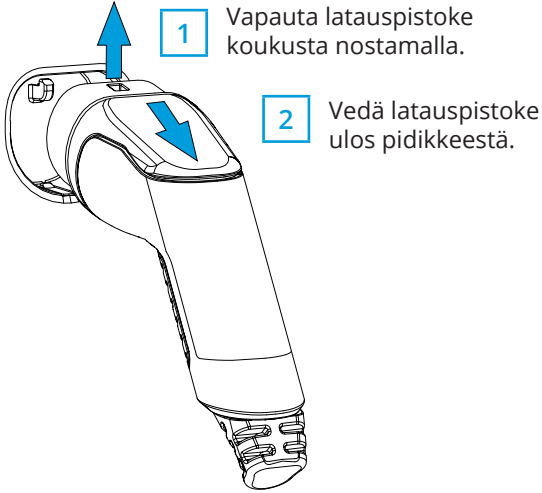

Vapaa lataus

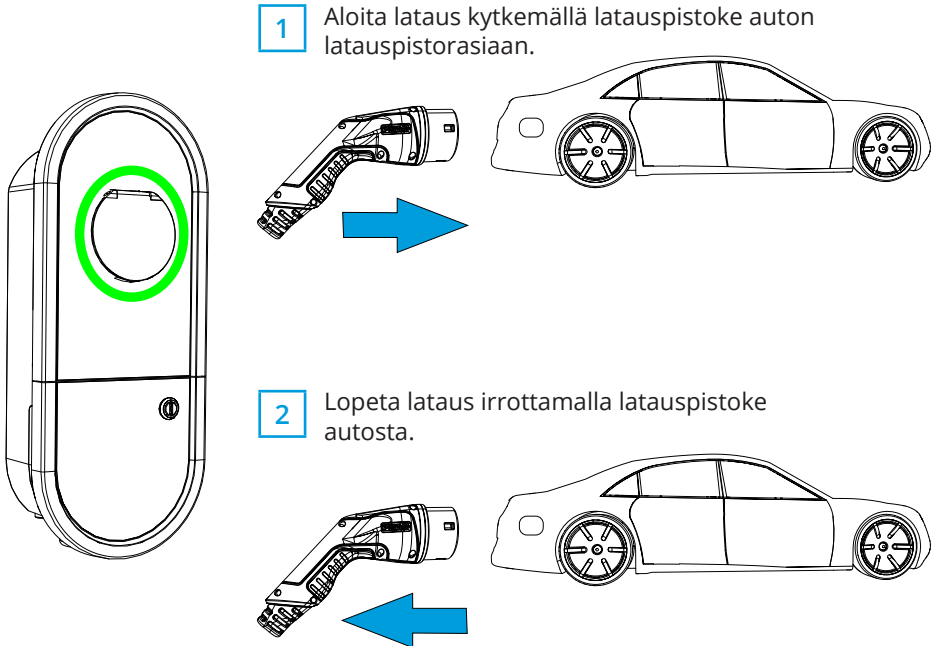



Lataus RFID-tunnisteella

1 Kytke latauskaapeli autoon.

Kytke latauskaapeli latauslaitteeseen
(EVH...-A2RMO / EVH161-A2RMD).

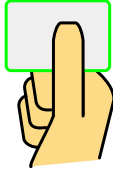
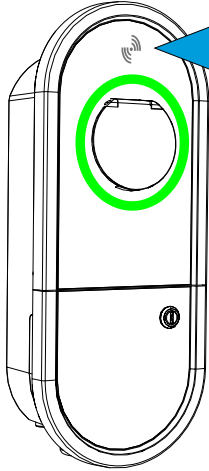
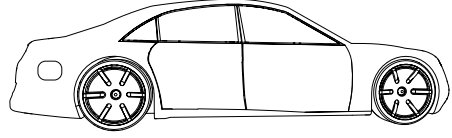
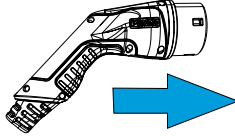

2 Näytä RFID-tunnistetta
RFID-lukualueelle.

Lataustapahtuma alkaa.

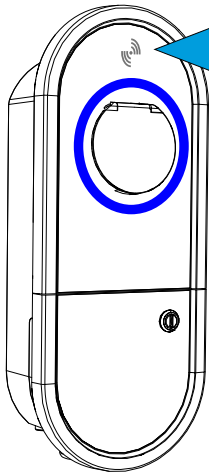

3 Näytä RFID-tunnistetta
RFID-lukualueelle.

Lataustapahtuma loppuu.

4 Irrota latauskaapeli latauslaitteesta
(EVH...-A2RMO / EVH161-A2RMD).

Irrota latauskaapeli autosta.

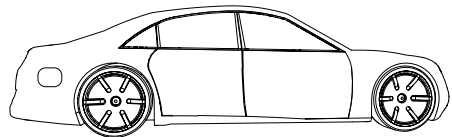
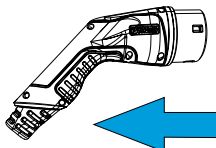

*Katso lisäohjeita pakkauksessa olevasta englanninkielisestä ohjeesta.
Voit myös ladata suomenkielisen asennus- ja käyttöohjeen www.ensto.com.*



Ohjeita asentajalle

Turvallisuusohjeet



Sähköalan ammattihenkilö

- Asennuksen saa suorittaa vain sähköalan ammattihenkilö, jolla on siihen riittävä pätevyys.
- Lue pakkauksessa oleva englanninkielinen ohje huolellisesti ennen asennustyön aloittamista. Voit myös ladata suomenkielisen asennus- ja käyttöohjeen www.ensto.com.



VAROITUS

Sähköiskun vaara! Palovaara!

- *Virheellinen asennus voi aiheuttaa henkilö- ja omaisuusvahinkoja.*
- *Älä kytke latauslaitetta verkkojännitteeseen ennen kuin asennustyö on valmis.*

Syöttöliitäntä

Suojalaitteet: RCBO on integroitu

EVH...-ACRM0 / EVH...-A2RM0

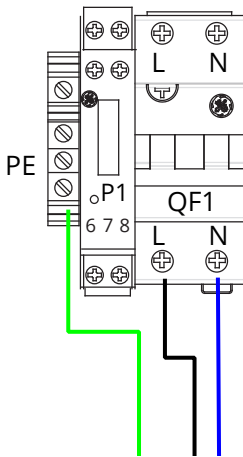

Syöttö
Cu 2.5 - 10 mm²

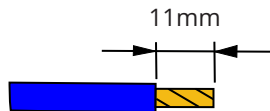

EVH161-A2RMD

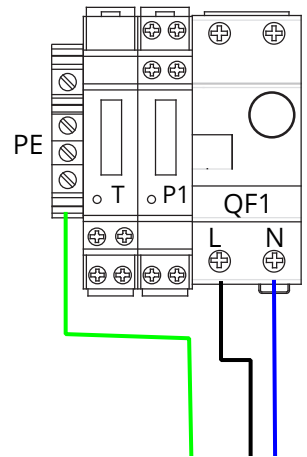

Syöttö
Cu 2.5 - 10 mm²

Latauslaitteen käyttöönotto

Voit määritellä latauslaitteen asetuksia EV Managerin avulla. Katso EV Managerin käyttöopas <https://evwiki.ensto.technology/display/CHWI/EV+Manager>



Bruksanvisning

Säkerhetsinstruktioner



VARNING

Fara för elektrisk stöt! Brandrisk!

- *Personer som inte har tillräcklig kunskap att följa givna anvisningar, får inte använda den här laddstationen.*
- *Använd inte den här laddstationen, om själva laddstationen eller laddkabeln verkar vara skadad.*
- *Använd inte hushållsuttaget för att ladda ett elfordon.*
- *Endast en fackkunning person får installera laddstationen.*

Ensto One Apartment egenskaper

Tillgängliga egenskaper beror på laddstationens modell.

Ensto samlar in data från laddstationerna som är anslutna till Internet. Dessa anonymiserade data kan användas för att utveckla nya digitala tjänster och förbättra användarupplevelsen och Enstos erbjudande.

EVH...-ACRMO

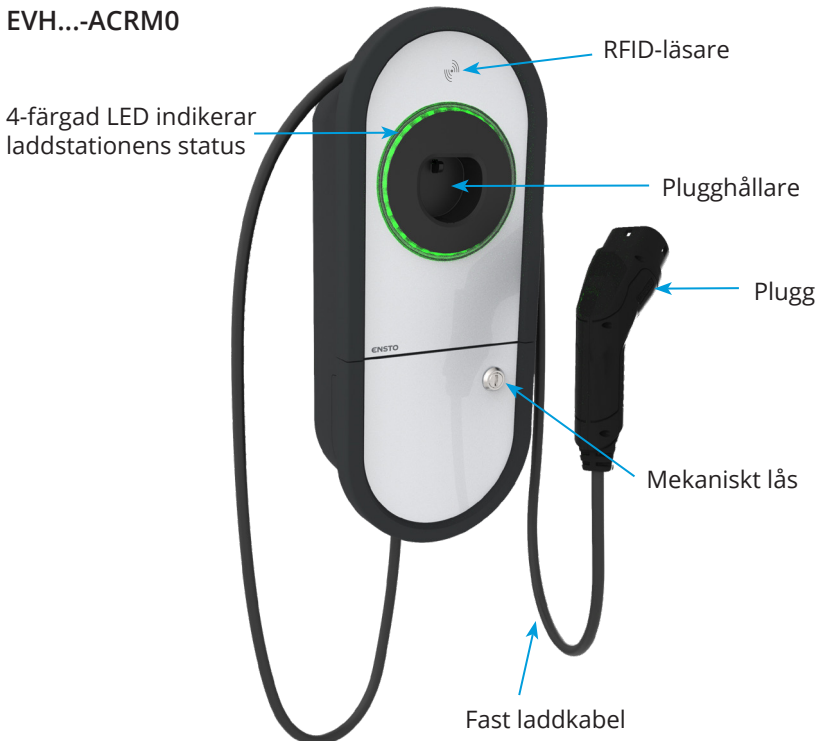



EVH...-A2RM0 / EVH161-A2RMD

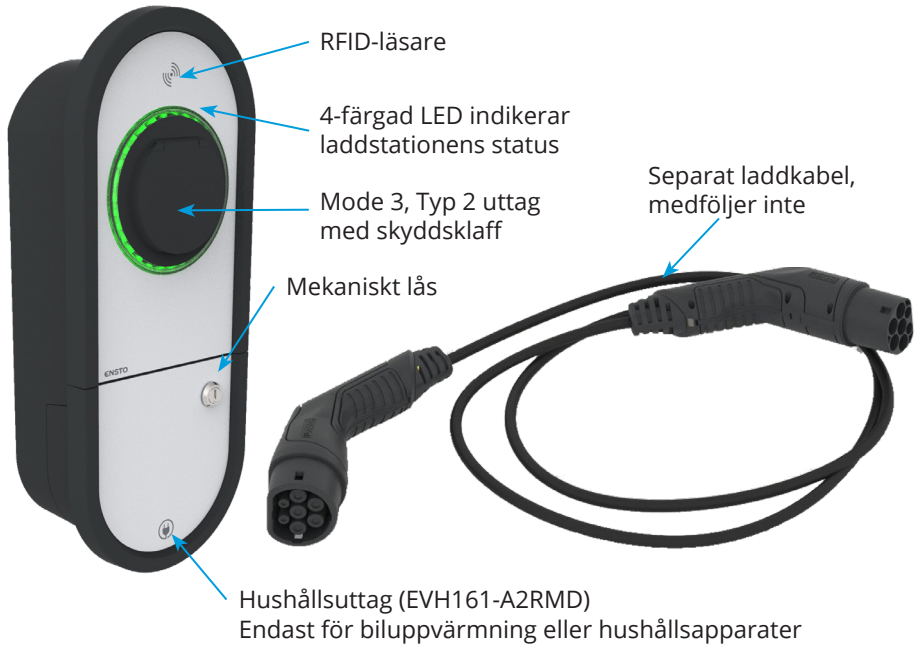

LED indikator

Laddstationens status	LED
Laddstationen är ledig och kan användas	
RFID är läst, identifiering pågår	
Tillstånd att ladda är nekat	
Tillstånd att ladda är beviljat, du kan börja laddning	
Medan du ansluter laddkabeln	
Elfordonet är anslutet, laddning har inte startat	
Elfordonet är anslutet, laddning startar	
Laddning pågår	
Feltillstånd	
Uppdatering av programvaran pågår. Stäng inte av strömmen eller använd laddstationen under uppdatering.	



Laddning

Laddstationerna EVH161-ACRM0 och EVH132-ACRM0 har en fast laddkabel.

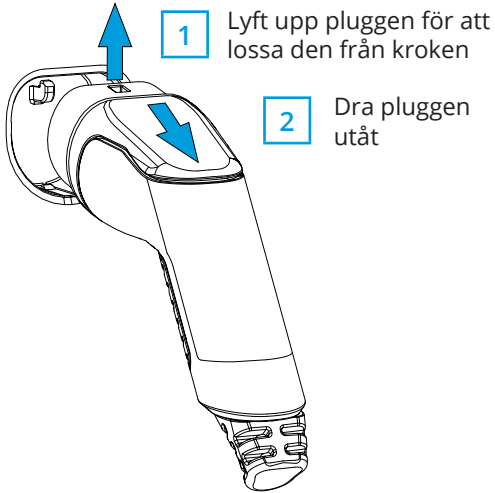

Gratis laddning

- 1 Starta laddning genom att ansluta ditt elfordon till ladduttaget.

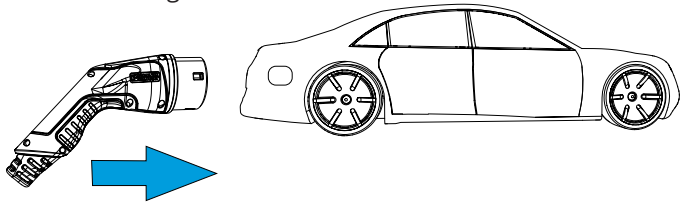
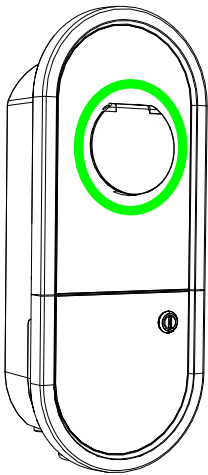

- 2 Stoppa laddning genom att dra ur pluggen.

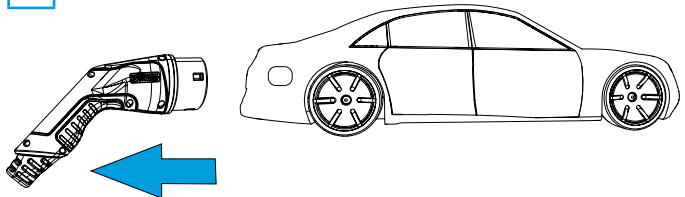



Laddning med RFID

- 1** Anslut laddkabeln till elfordonet.
Anslut laddkabeln till laddstationen
(EVH...-A2RM0 / EVH161-A2RMD).

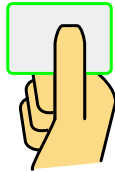
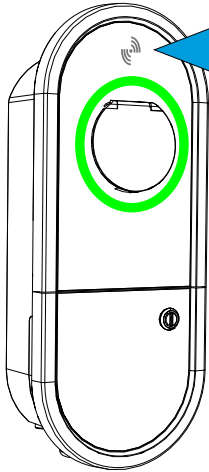
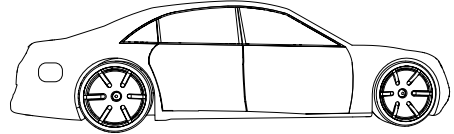
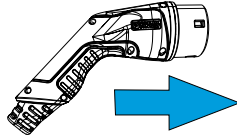

- 2** Visa din RFID-tag till RFID-läsområdet.
Laddning startar.

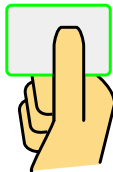
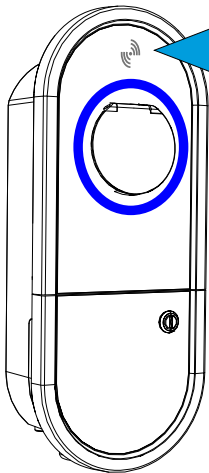

- 3** Visa din RFID-tag till RFID-läsområdet.
Laddning stoppar.

- 4** Dra ur laddkabeln från laddstationen
(EVH...-A2RM0 / EVH161-A2RMD).
Dra ur laddkabeln från elfordonet.

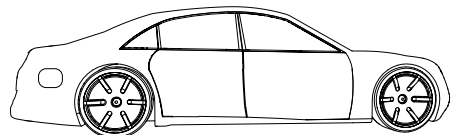
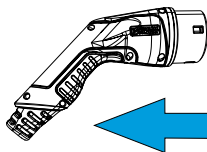

För mera detaljerade instruktioner se den medföljande engelska guiden. Du kan också ladda ner den svenska installations- och bruksanvisningen på www.ensto.com



Anvisningar för Installatör

Säkerhetsinstruktioner



Fackkunnig person

- Endast en fackkunnig person får installera laddstationen.
- Läs den medföljande engelska guiden noga innan du börjar installationsarbetet. Du kan också ladda ner den svenska installations- och bruksanvisningen på www.ensto.com



VARNING

Fara för elektrisk stöt! Brandrisk!

- *Felaktig installation kan leda till personskada eller materiella skador.*
- *Slå inte på strömförsörjning innan installationen är klar.*

Nätanslutning

Skyddsanordningar: RCBO är integrerad

EVH...-ACRMO / EVH...-A2RMO

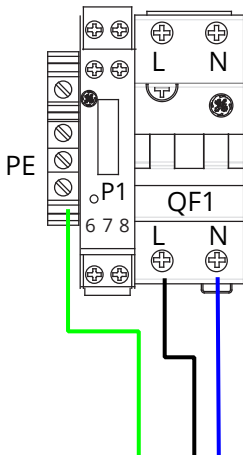

Matarkabel
Cu 2.5 - 10 mm²

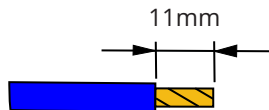

EVH161-A2RMD

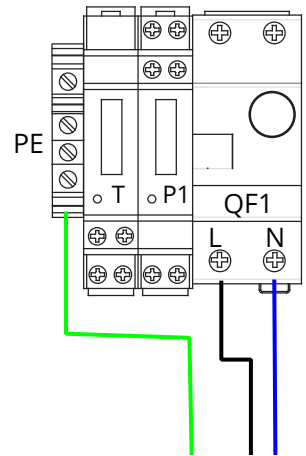

Matarkabel
Cu 2.5 - 10 mm²

Idrifttagning av laddstation

Du kan konfigurera laddstationens inställningar med EV Manager. Se användarhandboken för EV Manager <https://ewiki.ensto.technology/display/CHWI/EV+Manager>



Bruksanvisning

Sikkerhetsinstruksjoner



ADVARSEL

Risiko for elektriskjokk! Brannfare!

- *Personer som ikke har tilstrekkelig kunnskap til å følge gitte instruksjoner, skal ikke bruke denne laderen.*
- *Hvis skader på lader eller ladekabel, skal ikke laderen benyttes.*
- *Do not use the domestic socket to charge an electric vehicle.*
- *Ensto One Home lader skal kun installeres av kvalifisert elektriker eller installatør.*

Ensto One Apartment egenskaper

Tilgjengelige egenskaper er avhengig av ladermodell.

Ensto samler inn data fra ladestasjonene som er koblet til internet. Denne informasjonen er anonymisert og brukes til å utvikle nye digitale tjenester samt og forbedre bruker opplevelsen og Enstos tilbud til brukerne.

EVH...-ACRMO





EVH...-A2RM0 / EVH161-A2RMD

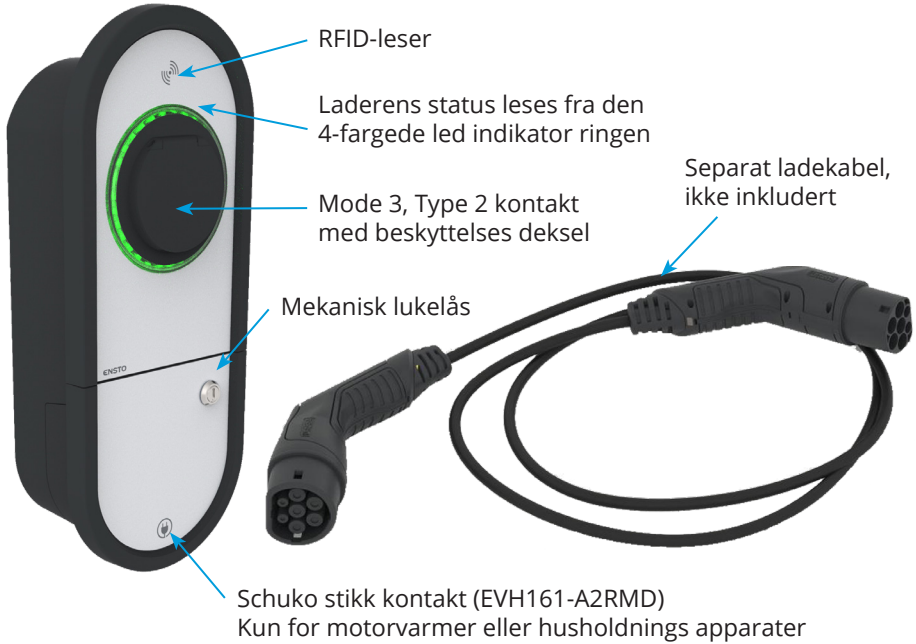

Status LED lys mønster

Lader status	LED
Laderen er ledig og klar for bruk	
RFID lest, autorisering pågår	
Lade autorisering avvist	
Autorisering akseptert, lading tillatt	
Tilkobling av ladekabel	
Bil tilkoblet, lading ikke startet	
Bil tilkoblet, lading startet	
Lading pågår	
Feil på lader	
Software oppgradering pågår. <i>Slå ikke av strømmen til laderen mens oppdatering pågår.</i>	



Lading

EVH161-ACRM0 og EVH132-ACRM0 er utstyrt med fastmontert ladekabel.

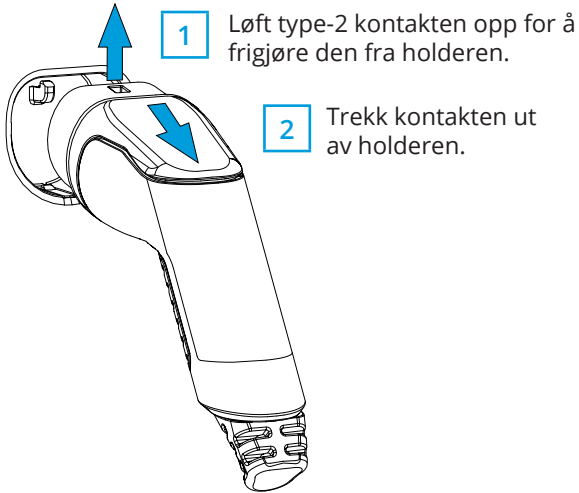

Fri lading

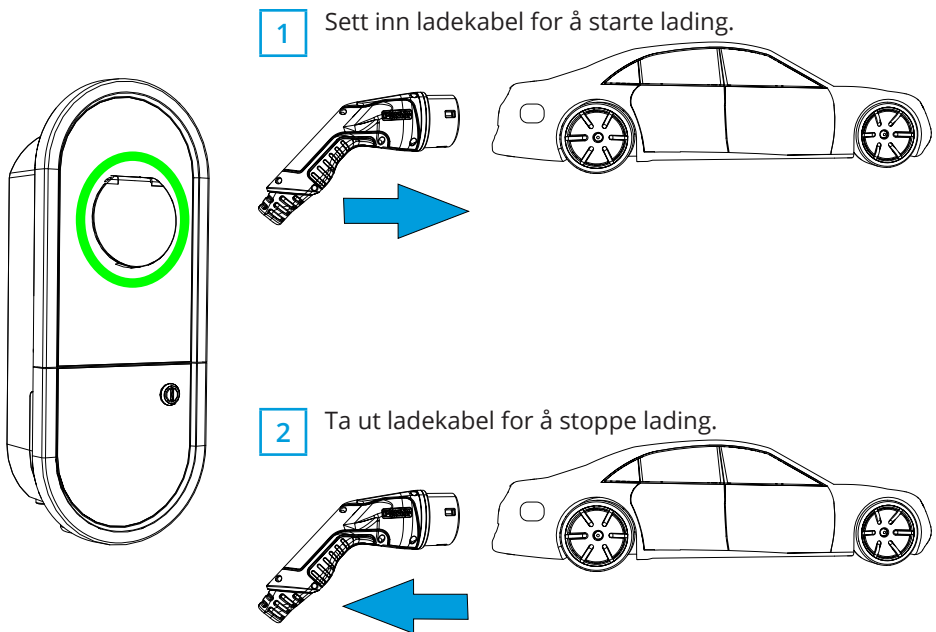



Lade med RFID

- 1** Koble ladekabel til bilen.
Koble ladekabel til lader (EVH...-A2RM0 / EVH161-A2RMD).

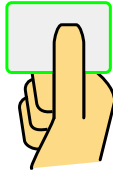
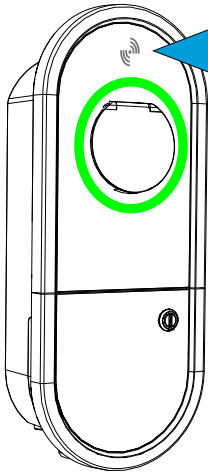
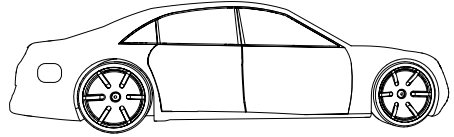
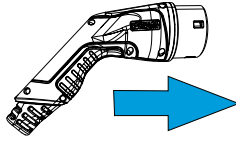

- 2** Sveip RFID kort over RFID leser.
Lading starter.

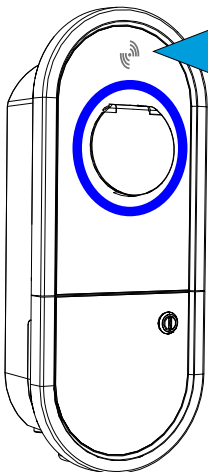

- 3** Sveip RFID kort over RFID leser.
Lading stopper.

- 4** Koble ladekabel ut fra laderen (EVH...-A2RM0 / EVH161-A2RMD).
Koble ladekabelen ut fra bilen.

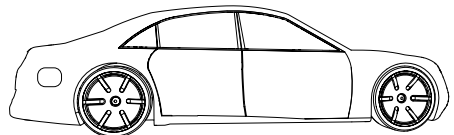
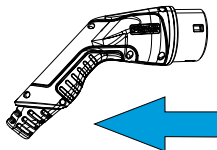



Instruksjoner for installatør

Sikkerhetsinstruksjoner



Kvalifisert elektriker eller installatør

- Ensto One Home lader skal kun installeres av kvalifisert elektriker eller installatør.
- Les den vedlagte engelske guiden nøye før du begynner installasjonsarbeidet. Du kan også laste ned den norske installasjons- og bruksveiledningen på www.ensto.com.



Advarsel

Risiko for elektrisk sjokk! Brannrisiko!

- Ikke forskriftsmessig installasjon kan medføre personskade og materielle skader.
- Slå ikke på strøm tilførsel før installasjons arbeide er ferdigstilt.

Strømtilførsel

Sikkerhetsfunksjoner: RCBO inkludert i laderen.

EVH...-ACRM0 / EVH...-A2RM0

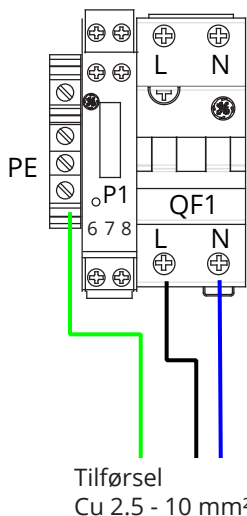

EVH161-A2RMD

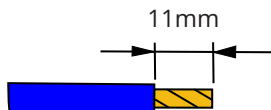
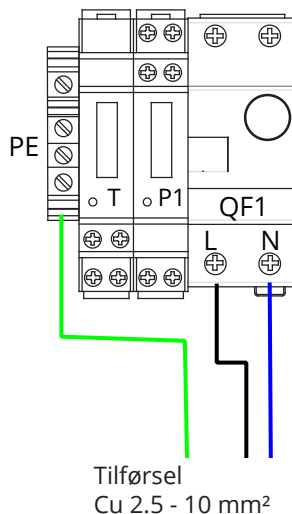

Installasjon av elbillader

Du kan konfigurere elbilladerens innstillinger med EV Manager. Vennligst les EV Managers bruker manual <https://ewiki.ensto.technology/display/CHWI/EV+Manager>



Guida utente

Indicazioni per la sicurezza



AVVERTENZE

Rischio di scossa elettrica o incendio!

- *Persone che non possono operare in accordo con il presente manuale non devono usare la stazione di ricarica.*
- *Non usare la stazione di ricarica se i cavi di ricarica o la stazione stessa risultano essere danneggiati.*
- *Non usare la presa domestica per ricaricare il veicolo elettrico.*
- *L'installazione deve essere eseguita solo da personale qualificato.*

Caratteristiche principali di Ensto One Home

Le funzionalità disponibili dipendono dal modello della stazione di ricarica.

Ensto acquisisce dati dalle stazioni di ricarica connesse ad Internet. Tali dati anonimi vengono usati per lo sviluppo di nuovi servizi digitali e per migliorare l'esperienza utente dei servizi offerti dalla Ensto.

EVH...-ACRMO





EVH...-A2RM0 / EVH161-A2RMD



Indicatori LED

Stato della stazione di ricarica	LED
La stazione di ricarica è libera e pronta all'uso.	
Lettura RFID, autorizzazione in corso.	
Autorizzazione ricarica rifiutata.	
Autorizzazione accettata, ricarica consentita.	
Durante il collegamento del cavo di ricarica.	
Veicolo connesso ma non in carica.	
Veicolo connesso, inizio carica.	
Ricarica in corso.	
Errore	
Aggiornamento del software in corso. <i>Non scollegare o usare la stazione di ricarica durante l'aggiornamento.</i>	



Ricarica

EVH161-ACRM0 e EVH132-ACRM0 sono dotati di un cavo di ricarica fisso.

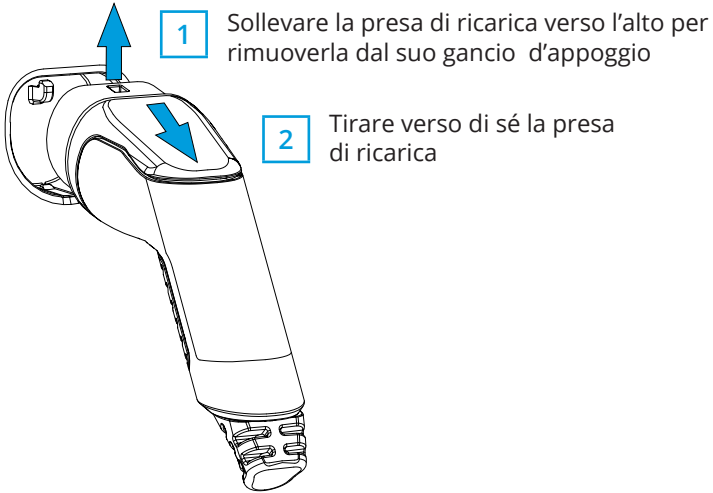

Ricarica libera

1 Collegare il cavo per iniziare la ricarica.

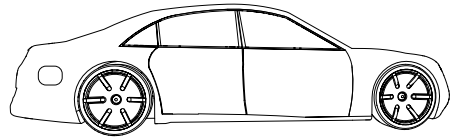
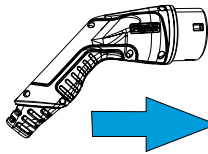
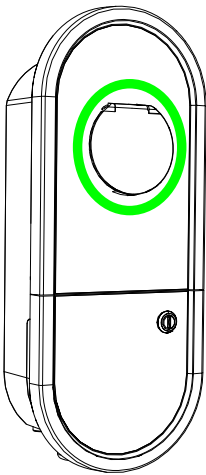

2 Scollegare il cavo per interrompere la ricarica.

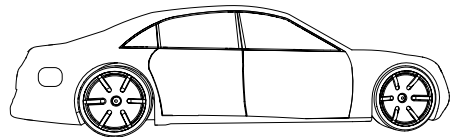
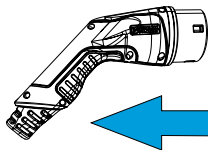



Ricarica con RFID

1 Collegare il cavo di ricarica all'auto.

Collegare il cavo di ricarica alla stazione di ricarica (EVH...-A2RM0 / EVH161-A2RMD).

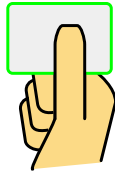
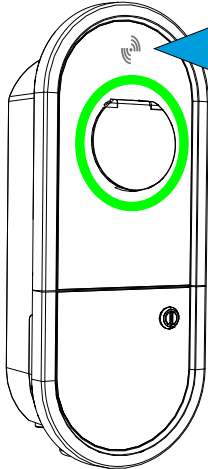
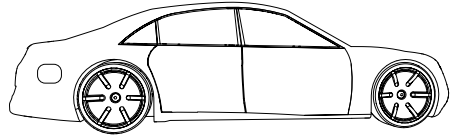
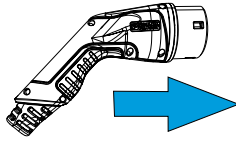

2 Avvicinare il tag RFID all'area di lettura RFID.

Inizio ricarica.

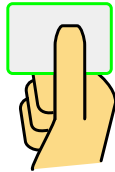
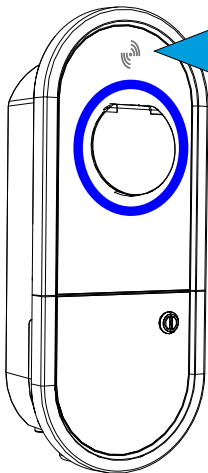

3 Avvicinare il tag RFID all'area di lettura RFID.

Fine ricarica.

4 Scollegare il cavo di ricarica dalla stazione di ricarica (EVH...-A2RM0 / EVH161-A2RMD).

Scollegare il cavo di ricarica dall'auto.

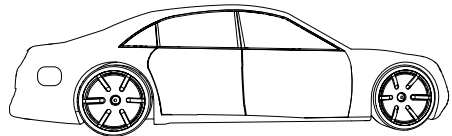
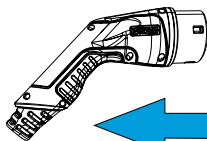

Per istruzioni più dettagliate, consultare il Manuale di installazione e d'uso incluso nella confezione. È possibile scaricare il manuale di installazione e d'uso in italiano dal sito www.ensto.com.



Indicazioni per l'installatore

Indicazioni per la sicurezza



Personale qualificato

- L'installazione deve essere eseguita solo da un elettricista qualificato.
- Leggere attentamente il Manuale di installazione e d'uso incluso nella confezione prima di procedere con l'installazione. È possibile scaricare il manuale di installazione e d'uso in italiano dal sito www.ensto.com.



AVVERTENZE

Rischio di scossa elettrica o incendio!

- *Un'installazione errata può causare gravi lesioni a persone e danni alle cose.*
- *Non attivare l'alimentazione elettrica prima che l'installazione sia completata.*

Alimentazione elettrica

Dispositivi di protezione: RCBO è integrato

EVH...-ACRM0 / EVH...-A2RM0

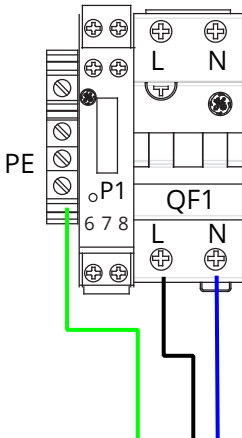

Alimentazione
Cu 2.5 - 10 mm²

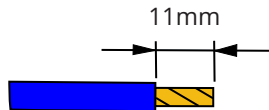

EVH161-A2RMD

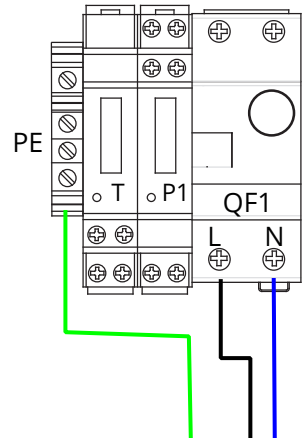

Alimentazione
Cu 2.5 - 10 mm²

Messa in servizio della stazione di ricarica.

Puoi configurare le impostazioni della stazione di ricarica tramite EV Manager. Si prega di consultare il Manuale utente EV Manager <https://ewiki.ensto.technology/display/CHWI/EV+Manager>



ENSTO

Ensto Chago Oy
Ensio Miettisen katu 2, P.O. Box 77
FIN-06101 Porvoo, Finland
Tel. +358 20 47 621
Customer service +358 200 29 007
ensto@ensto.com

